

ZOOMLION ROUGH TERRAIN CRANE ZRT400V



ZOOMLION

Zoomlion Heavy Industry Science & Technology Co.,Ltd.

Add: No.677, Lugu Road, Zoomlion Industrial Park, Changsha, Hunan, China, 410205

Copyright©2021 Zoomlion. All rights reserved. Reproduction and copying of any part of contents is not allowed for any purposes without Zoomlion's approval.



Product specifications are subject to change without notice and obligation. The photographs and/or drawing in this document are for illustrative purposes only. Please consult your local ZOOMLION dealer for more information.
The product is now under prototype status, the design and parameters of finalized version may subject to change without immediate notice.
website:en.zoomlion.com 2021.10.26

ZOOMLION

CONTENTS

HIGHLIGHTS	2
DIMENSIONS	3
WEIGHTS	3
LIFTING CAPACITY TABLES/LIFTING HEIGHT CURVE	4-7
TECHNICAL DESCRIPTION	8-9
TECHNICAL PARAMETERS	10

HIGHLIGHTS

- 1.Strong lifting performance**
- 33m main boom, super large U-shaped section, maximum rated lifting capacity 40t, 4.5t counterweight; Super strong outrigger + driving operation capacity with load, leading the industry in comprehensive lifting performance;
 - Four-wheel multi-mode steering, the maximum driving speed can reach to 38 km/h, and the maximum gradeability is 55%.
- 2.Stable and reliable**
- The main components are selected from international well-known brands, DF Cummins engine + DANA gearbox + MEICHI bridge. The whole machine has passed the strict operation and driving reliability test.
 - Mature modular design of crane.
- 3.Comfortable and durable**
- The new generation panoramic cab is equipped with front sliding window and panoramic skylight to make the vision more unobstructed and effectively reduce work fatigue.
 - 10 inch large display screen, force limiter display screen and body display screen are integrated, and the space layout of man-machine effect control room is convenient and comfortable.



DIMENSIONS

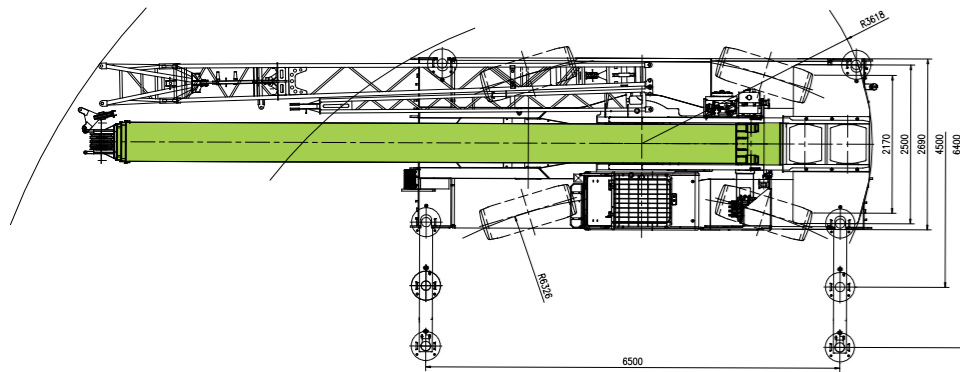
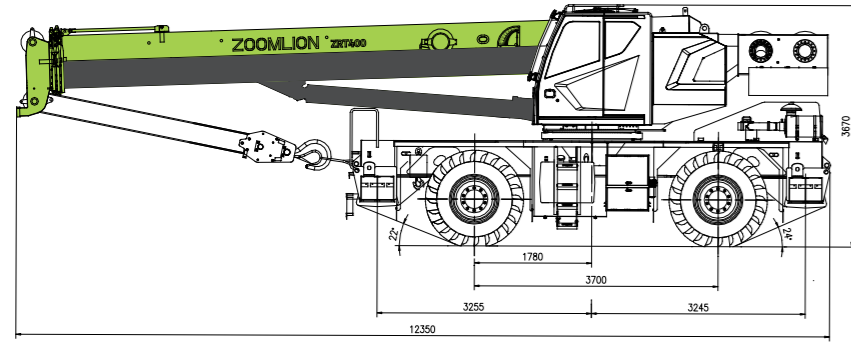

WEIGHTS

Hook block and hook ball

Rated load/t	Number of sheave	Reeving	Hook block weight/kg	Standard/Optional
40T	4	8	340	Standard
4.5T	-	1	90	Standard

Axle

Shaft	Front axle	Rear axle	Total weight
Axle load/t	15.9	15.1	31
Note	With main and auxiliary hooks		

Working speeds

	km/h min. MIN.	km/h max. MAX.	%	
20.5-25-28PR	0-1.6	38	55	6/R3

Drive	Operation Speed	Rope diameter/length	Max. single line pull
1	145m/min	Φ17mm/190m	5600Kg
2	145m/min	Φ17mm/110m	5600Kg
360°	0~2.8r/min		
	45/60s		
	50s/45s		

LIFTING HEIGHT CURVE

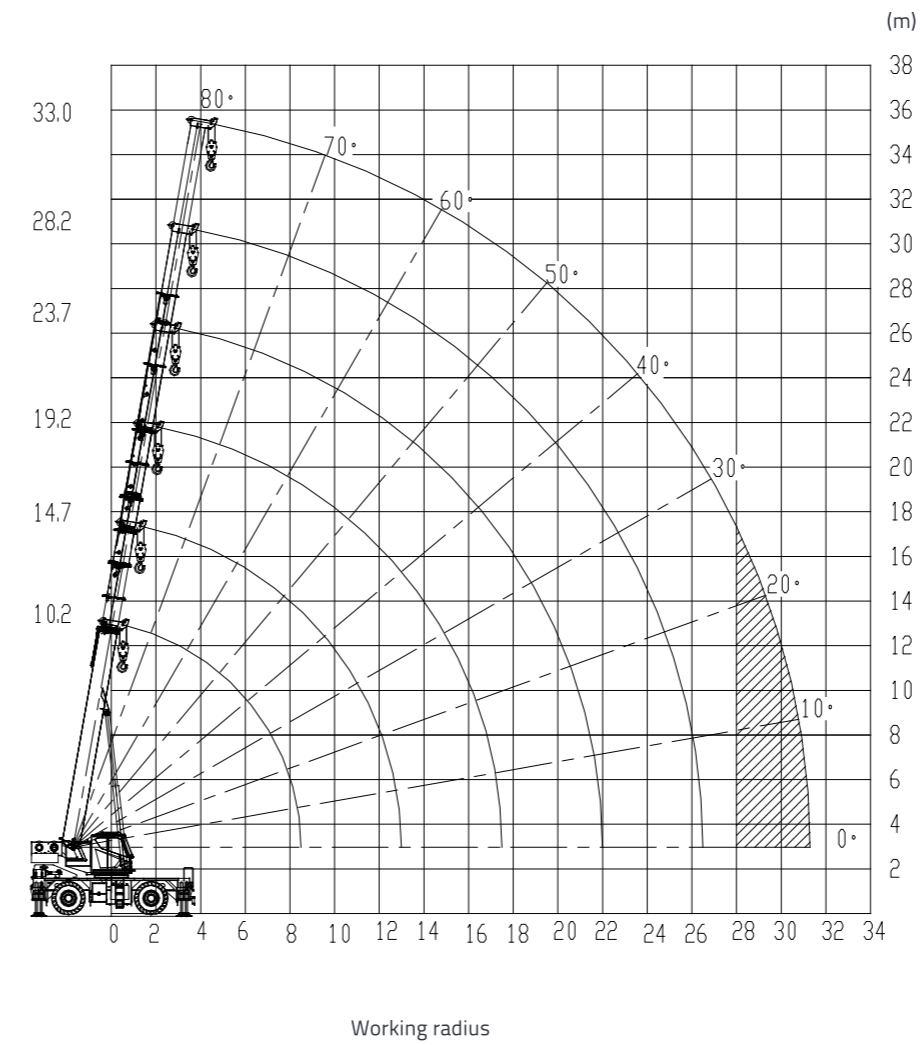

LIFTING CAPACITY TABLES



Working radius(m)	Outrigger fully extended, 4.5tcountweight					
	10.2	14.7	19.2	23.7	28.2	33
2.5	40000					
3.0	37000	23000				
3.5	34000	23000	22000			
4.0	31000	23000	22000	20000		
4.5	29000	23000	21000	18000		
5.0	25500	21500	20000	17000	14200	
5.5	23000	19500	18800	15800	14000	
6.0	20000	18000	17600	15000	13500	10000
7.0	17000	15500	15000	13500	12000	9800
8.0		13500	13000	12000	10600	9000
9.0		11500	11500	10800	9600	8400
10.0		9200	9600	9600	8700	7800
11.0		7500	8000	8200	8000	7200
12.0			7200	7400	6800	6600
14.0			5400	5600	5800	5600
16.0				4400	4500	4600
18.0				3400	3500	3600
20.0					2700	2800
22.0					2300	2300
24.0					1700	1800
26.0						1400
28.0						1100
30.0						
l(m)	0	4.5	9	13.5	18	22.8
Reeving	8	6	6	5	4	3
Hook	40t					

LIFTING CAPACITY TABLES

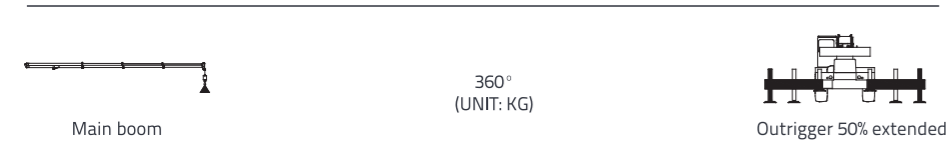

Working radius(m)	Outrigger 50% extended 4.5tcountweight unit: kg					
	10.2	14.7	19.2	23.7	28.2	33
3.0	35000	23000				
3.5	29000	23000	22000			
4.0	25000	23000	22000	20000		
4.5	22000	20000	19500	18000		
5.0	17500	17800	17500	17000	14200	
5.5	15000	15500	15500	15800	14000	
6.0	12000	13000	13500	14000	13500	10000
7.0	8500	9800	10000	10000	11000	9800
8.0		8000	8000	8400	8600	8500
9.0		6400	6600	7000	7000	7000
10.0		4800	5200	5600	5800	5800
11.0		4000	4500	4800	5000	5000
12.0			3800	4000	4200	4200
14.0			2800	3000	3000	3100
16.0				2200	2300	2400
18.0				1600	1700	1800
20.0					1400	1400
22.0					1000	1100
24.0					800	900
26.0						650
28.0						
30.0						
l(m)	0	4.5	9	13.5	18	22.8
Reeving	8	6	6	5	4	3
Hook	40t					



Working radius(m)	Outrigger fully retracted 4.5tcountweight unit: kg					
	10.2	14.7	19.2	23.7	28.2	33
3.0	20000	20000				
3.5	15000	15500	15000			
4.0	11000	11500	12000	12000		
4.5	9200	10000	9800	9800		
5.0	7800	8400	8400	8500	8500	
5.5	6400	7000	7200	7500	7500	
6.0	5200	5800	6200	6500	6500	6500
7.0	3600	4200	4600	4600	4800	5000
8.0		3000	3500	3600	3700	4000
9.0		2400	2800	3000	3200	3000
10.0		2000	2200	2400	2400	2400
11.0		1500	1700	1800	2000	2000
12.0			1400	1600	1700	1700
14.0			1000	1100	1100	1200
16.0				750	800	900
18.0						600
20.0						
22.0						
24.0						
26.0						
28.0						
30.0						
l(m)	0	4.5	9	13.5	18	22.8
Reeving	8	6	6	5	4	3
Hook	40t					

LIFTING HEIGHT CURVE

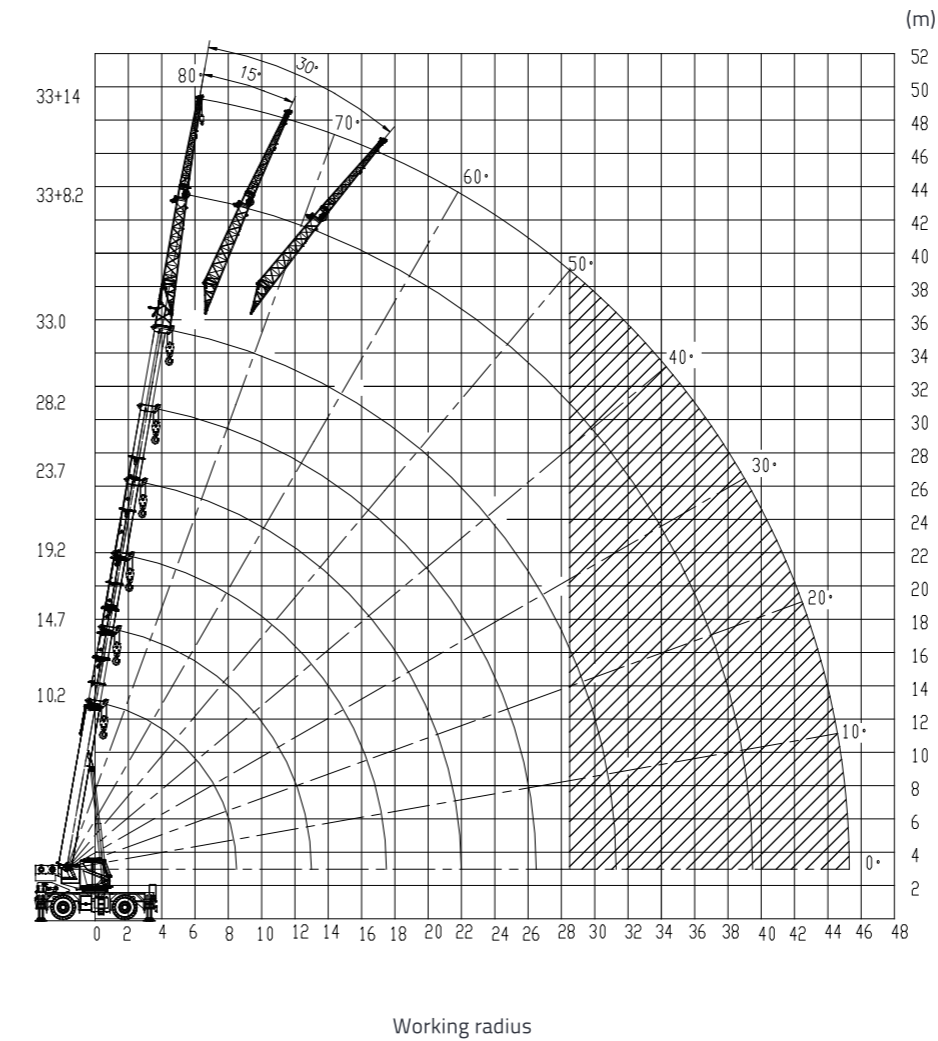

LIFTING CAPACITY TABLES

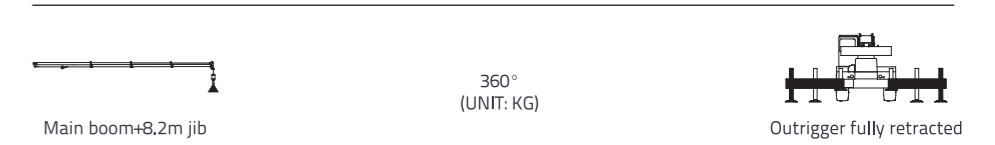

Boom angle (°)	Outrigger fully retracted 4.5tcountweight unit: kg					
	0°		15°		30°	
	Radius (m)	Capacity	Radius (m)	Capacity	Radius (m)	Capacity
80	7.5	4500	9.1	3000	10.5	2400
78	9	4200	10.6	2800	11.9	2300
76	10.5	4000	12	2700	13.3	2200
74	11.9	3600	13.4	2500	14.7	2100
72	13.3	3300	14.8	2400	16	2000
70	14.7	3000	16.2	2200	17.3	1900
68	16.1	2800	17.5	2100	18.6	1800
66	17.4	2600	18.7	2000	19.8	1700
64	18.7	2300	20	1900	21.1	1550
62	19.9	2100	21.2	1700	22.2	1400
60	21.1	1800	22.4	1500	23.4	1300
58	22.2	1600	23.6	1400	24.5	1200
56	23.3	1500	24.6	1200	25.5	1100
54	24.4	1300	25.7	1100	26.5	1000
52	25.4	1100	26.7	1000	27.5	900
50	26.5	1000	28.6	900	28.4	800
48	27.5	900	29.5	800	29.3	700
46	28.4	700	29.5	600	30.1	550
Reeving	1					
Hook	4.5t					

LIFTING CAPACITY TABLES

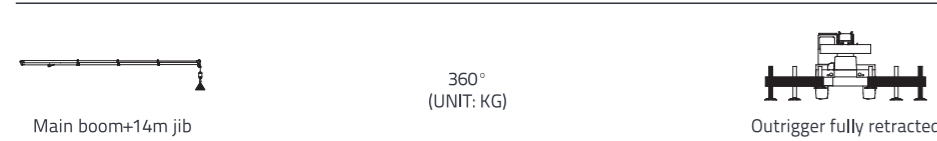

Boom angle (°)	Outrigger fully retracted 4.5tcountweight unit: kg					
	0°		15°		30°	
	Radius (m)	Capacity	Radius (m)	Capacity	Radius (m)	Capacity
80	8.5	2500	11.6	1800	14.3	1200
78	10.2	2400	13.2	1700	15.9	1200
76	11.9	2200	14.8	1550	17.4	1100
74	13.5	2000	16.4	1400	18.9	1100
72	15.1	1800	18	1350	20.3	1100
70	16.7	1700	19.5	1300	21.7	1000
68	18.3	1500	21	1200	23.1	1000
66	19.8	1400	22.4	1100	24.5	950
64	21.3	1300	23.8	1000	25.8	900
62	22.7	1200	25.2	900	27.1	850
60	24.2	1100	26.6	850	28.4	800
58	25.5	1000	27.9	800	29.6	800
56	26.9	950	29.1	750	30.7	750
54	28.2	850	30.4	700	31.8	700
52	29.5	800	31.6	600	32.9	550
50	30.7	700				
Reeving	1					
Hook	4.5t					

TECHNICAL DESCRIPTION



Engine

Engine type---- DF CUmmins QSB 6.7
 Rated power--- 129KW/2200RPM
 Oil tank capacity-----250L
 Exhaust emissions: Non-road Emission Standard III



MAIN HOOK

Rotatable main hook: 40 t, with 4 sheaves and hook latch, secured at the chassis frame in front of the slewing table.
 Rotatable auxiliary hook: 4.5 ton, with hook latch, used with the rooster sheave and jib, secured at the auxiliary hook holder on the chassis frame.
 Rotatable hook: 85t (optional), with 6 sheaves and a hook latch, secured at the chassis frame in front of the slewing table.



JIB

It consists of two jib sections of lattice structure. The jib section II is secured into the jib section I, and can be extended outward from one side of the section I. The whole jib is side stowed with the main boom via moveable pins during driving.
 A sheave is assembled at the jib head.
 Offset: 0°, 15° and 30°
 Jib length: 8.2m, 14 m



MAIN AND AUXILARY WINCHES

The main and auxiliary winches are equipped with the same spare parts.
 Max. hoist rope strength: 5600 kg
 Max. hoist rope speed: 145 m/min (At the 4th layer)
 Rope diameter: 17 mm
 Main winch rope length: 190 m
 Auxiliary winch rope length: 110 m



MAIN BOOM

The box-shaped main boom consists of 4 U-type boom sections made of high-strength steel.
 The main boom head is equipped with 6 sheaves, which is convenient for changing reeving factors without removing the wedges. The rooster sheave and a dismantable pulley block are included in the standard configuration.
 Min. main boom length (with telescopic sections completely retracted): 10200 mm
 Max. main boom length (with telescopic sections completely extended): 33000 mm
 Min. telescoping out time: about 50 s
 Derrick angle and speed: -2° - 80° / 45 s



SLEWING MACHENISM

It consists of a hydraulic motor, planetary gear reducer, a pinion gear and a slewing bearing, etc. Via the planetary gear reducer, the hydraulic motor drives the pinion gear to rotate and makes the slewing bearing outer ring rotate around its inner toothed ring fixed on chassis frame, providing superstructure with 360° unlimited slewing.
 Hydraulically controlled usually-closed brake, capable of free slewing function, and installed with a slewing lockout device.
 Swing speed: 0 – 2.8 r/min.



HYDRAULIC SYSTEM

The dual variable plunger pumps supply oil to the telescoping, derricking and hoist mechanisms.
 A gear pump supplies oil to the outrigger, braking system, oil radiator of the torque converter and air conditioner.
 Another gear pump mounted on the engine supplies oil to the slewing, steering system.
 Hydraulic oil tank capacity-----650 L

TECHNICAL DESCRIPTION



OPERATOR CAB

The cab is side-mounted and adopts left-hand drive. A single seat is installed inside the cab.

There are two control boxes on the both sides of operator's seat. The left / right control box can be pulled up. The controls of the superstructure are arranged according to the requirements of ASME B30.5-2007 standard and comply with ISO (International Organization for Standardization) standard.

Length: 1810 ± 5 mm

Width: 910 ± 5 mm

Height: 1710 ± 5 mm



OUTRIGGER SYSTEM

4 H-type outriggers, hydraulically controlled, can be operated in the cab simultaneously or independently. Each vertical jack cylinder is equipped with a two-way hydraulic lock to ensure that outriggers are secured reliably during working or driving.

Outrigger boxes are directly welded onto the chassis frame.

The outriggers can be completely extended, intermediately extended or completely retracted for different crane operations.

Outrigger spread (L): 6500 mm

Outrigger spread (W): 6400 mm (fully extended)

4500 mm (half extended)

2500 mm (fully retracted)



STEERING

Fully-hydraulic power steering gear, The cylinder of steering and driving axle is controlled by the steering wheel to realize crane steering.

4 steering modes:

2-wheel steering – front wheel steering

2-wheel steering – rear wheel steering

4-wheel steering – all-wheel steering

4-wheel steering – crab steering



AXLES

Front axle: A rigidly connected steering and driving axle, installed with a planetary reducer and a brake.

Rear axle: A full-floating steering and driving axle, installed with a planetary reducer and a brake.



BRAKES

Service brake: Hydraulically controlled disc brake on 4 wheels

Parking brake: Hydraulically released parking brake, under the action of the spring mounted on the input shaft of front axle.



ELECTRIC SYSTEM

2 batteries with 12 V rated voltage and 120 Ah rated current



SAFETY DEVICE

Rated capacity indicator (RCI)

Rotating beacon and horn

Hoisting limit switch

Lower limit switch

Balance valve

Hydraulic lock

Hydraulic safety valve

Swing brake

Swing lockout device

Boom angle indicator

Outrigger beam retaining pin

Emergency stop button



SUSPENSION SYSTEM

Front axle: rigidly mounted to the chassis frame

Rear axle: oscillation axle, connecting to chassis frame via a hydraulic suspension cylinder



COUNTERWEIGHT

Counterweights: 4500kg (17196lbs)

Length.....2680mm

Width.....1240mm

Height..... 370mm

TECHNICAL PARAMETERS

Type	Item	Value	
Working performance	Max. rated lifting capacity × working radius	kg.m	40000×2.5
	Max.load moment of basic boom	kN.m	1305
	Max.load moment of main boom(fully extended)	kN.m	792
	Max. lifting height of main boom (fully extended)	m	33.9
	Max. lifting height of jib	m	47.8
Dimensions	Overall dimensions (L × W × H)	mm	12360×2690×3650
	Outrigger spread(Height × Width)	mm	6500×6400
	Main boom length	mm	10200~33000
	Jib length	mm	8200~14000
	Boom angle	°	-2~80
	Slewing range		360°
Working speeds	Max. hoist rope speed (Main winch)	m/min	145
	Min. boom telescoping out time	s	50
	Min. boom telescoping in time	s	45
	Min. boom derricking up time	s	45
	Min. boom derricking down time	s	60
	Slewing speed	r/min	0~2.8
Hydraulic system	Rated working pressure	MPa	28
	tank capacity	L	650
Gross vehicle mass	Gross weight	kg	31000
	Front weight	kg	15900
	Rear weight	kg	15100
Driving	Highest driving speed (forward/backward)	km/h	38/38
	Wheelbase	mm	3700
	Treads(Front / Rear)	mm	2170
	Max. gradeability	%	55